

VIC-GROOVER
OPERATING INSTRUCTIONS

VG-1

Rev. 5/90



**OPERATING INSTRUCTIONS
VIC-GROOVER®**

Individual Cut Grooving Tools

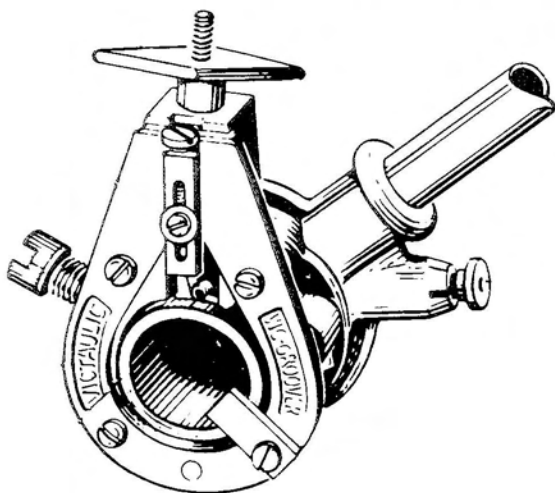

CAUTION

For Your Own Safety Before Assembling
and Operating This Unit, Read This
Operator's Manual Carefully and
Completely. Learn The Operation,
Applications and Potential Hazards Peculiar
To This Unit.

INDEX

Operator Safety Instructions	3
Introduction	4
Receiving Tool	4
Tool Nomenclature	5
Pipe Vise Setup	6
Pipe Preparation	6
Mounting the Pipe for Grooving	6
Mounting of Tool on Pipe	7
Attaching Power Drive	7
Figures 1 and 2	8
Power Drive — Power Hookup	9
Extension Cord Requirements	9
Adjusting the Groove Diameter	10
Grooving	12
Dismounting Tool	13
Tool Maintenance	13
Tool bit changes	14
Figure 3	15
Resharpener Tool Bits	15
Figure 4	16
Trouble Shooting	17
Operating Data Table	21
Grooving Tool Accessories	21
Tool Bit/Pipe Stop Selection Chart	22
Standard IPS and ES Grooving Specifications	23
Ductile/Cast Iron Grooving Specifications	24
Parts Ordering Information	25
Repair Parts List and Illustrations	25-30

OPERATOR SAFETY INSTRUCTIONS

These tools are designed for cut grooving pipe. To accomplish this function requires some dexterity and mechanical skills, as well as sound safety habits.

Although these tools are manufactured for safe, dependable operation, it is impossible to anticipate that combination of circumstances which could result in an accident. The following instructions are recommended for safe operation of the tools. Failure to follow these instructions may result in injury to the operator, damage to the tools, or an improper groove.

The operator is cautioned always to practice "Safety First" during each phase of use, including setup and maintenance of these units.

1. Read and understand this Tool Operating Instructions Manual before operating or performing maintenance on these tools. Become familiar with the tool's operations, applications, and limitations. Be particularly aware of its specific hazards. Store the operator's manual in a clean area and always at a readily available location. Additional copies at no charge are available upon request by writing to the Victaulic Tool Company.
2. Inspect the equipment. Before starting the tool, check the movable parts for any obstructions. Be certain that guards and tool parts are properly installed and secured.

3. Prevent accidental startings. If tool is power driven, place switch on the attached power drive in "OFF" position prior to plugging in unit. **Always use a foot pedal control** for the power drive.
4. Ground the Power Drive. If tool is power driven, be certain the power drive is connected to an internally grounded electrical system.
5. Keep work area clean. Keep the work area adjacent to the tool clear of clutter for unobstructed movement of the operator. Remove all oil or coolant spills. Remove shavings from the tool as required to maintain correct operating clearance.
6. Use pipe supports. For long and heavy work, use floor mounted pipe stands.
7. Wear proper clothing. Loose clothing can get easily entangled in moving parts. When operating tool, do not wear unbuttoned jackets, loose sleeve cuffs, neckties, long hair, etc. Safety glasses and shoes should be worn.
8. Secure tool, drive equipment, and work. If tool is power driven, make certain that the power drive equipment is securely fastened to the floor and/or operated in accordance with power drive manufacturer's instructions. Be sure that work is secured properly in a pipe vise which is bolted or securely fastened to the floor.
9. Always maintain tool. Keep tool clean and cutting tools sharp for safe, dependable operation. Follow lubricating instructions. Report any unsafe condition for immediate correction.
10. Keep alert. Do not operate tool if ill or drowsy from medication or fatigue. Avoid horseplay around equipment and keep bystanders a safe distance from equipment.
11. Operate on switch side only. If tool is power driven, it must be operated with a foot pedal control located for easy operator access. Never reach across moving parts or material being worked on. Switch should always be accessible to operator.
12. Operate in proper environment. When power driven, the tool should not be operated in damp locations. Wear hearing protection in noisy shop operations. Insure proper illumination in work area.
13. Do not misuse tool. Perform only the functions for which the tool is designed. Do not force tool.
14. If power driven, disconnect power cord prior to servicing. Repair should be attempted only by authorized personnel. Always disconnect power cord or power before servicing or making any adjustments.
15. Do not operate tool at speeds exceeding those specified in these "Tool Operating Instructions".
16. Pipe must be properly prepared in accordance with pipe preparation specifications.

INTRODUCTION

Individual Vic-Groover tools are designed for cut grooving various pipe materials and are available in the following IPS sizes $\frac{3}{4}$ ", 1", $1\frac{1}{4}$ ", $1\frac{1}{2}$ ", 2", $2\frac{1}{2}$ ", 3", $3\frac{1}{2}$ ", 4", 5", 6", and 8". An adjustable Vic-Groover (VG-46) is available for cut grooving 4", 5", and 6" IPS size pipe. Standard units will cut groove steel and aluminum pipe. Tool bits are available for cutting stainless steel (Types 304 and 316) and PVC plastic pipe. "ES" tool bits and pipe stops are also available.

Cast iron size (AWWA) Vic-Groovers are available in sizes 3", 4", and 6". They are suitable for cut grooving gray cast iron or ductile iron to standard rigid grooving specifications or flexible groove specifications.

During operation the tool (except VG-46) grips the pipe between two external rollers and a clamping screw, and rotates around the pipe in a clockwise direction. While being driven in a clockwise direction, the tool pulls itself tightly against the pipe end. The VE-46 clamps onto the pipe end and only the forward part of the tool rotates. The clamped portion of the tool acts as a guide for the rotating forward part.

The tool bit, which does the cutting, is spring loaded against the pipe. On 5" and larger, the VG-46 tool bit removes material until the depth stop, mounted directly adjacent to the tool bit, contacts the pipe surface. The pipe stop is mounted in the same holder as the tool bit and prevents the bit from cutting deeper into the pipe, thereby assuring uniformity of groove depth. On 4" and smaller Vic-Groovers, the depth stop is mounted on the front cover of the tool for easy adjustment.

Vic-Groovers do not contact the inside surface of the pipe and are ideal for grooving resiliently lined pipe and pipe with non-uniform wall thicknesses.

Vic-Groover standard high-speed tool bits are designed for long life and are resharpenable. The 8" Vic-Groover and the 4" to 6" adjustable Vic-Groover utilize high-speed tool bits with two cutting edges (one at each end) for extended tool bit life. These, too, are resharpenable. The cast iron size Vic-Groovers use carbide-tipped tool bits for the harder cast and ductile iron pipe and are not suitable for resharpening.

RECEIVING TOOL

Vic-Groover Tools are individually packaged in heavy cardboard containers with the ratchet handle protruding from the box.

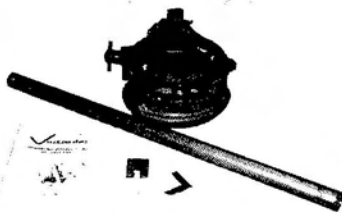

Upon receipt, check to be certain the tool is the correct size and all necessary parts are included. See above photo. Included should be:

- (1) Vic-Groover Tool
- (1) Extra Tool Bit (wired to tool)
- (1) Vic-Groover Gauge of the proper size
- (1) Ratchet Handle (installed in tool)
- (2) Operating Instruction Manuals

If incomplete, contact your Victaulic Distributor or the Victaulic Tool Company.

Unless otherwise specified on the order, IPS size Vic-Groovers will be set up for standard IPS grooving and cast iron size Vic-Groovers will be set up for cast iron rigid grooving. If ordered set up for grooving of other types of pipe or styles of groove, the tool will be set as ordered (see note below). For grooving to specifications other than those set "as shipped", see "Tool Adjustments".

NOTE: Tools ordered set for grooving to other than standard IPS or CIR specifications are provided set as ordered with correct tool bit and pipe stops mounted in tool. Also supplied is one extra tool bit of the same type. For example, a 2" Vic-Groover ordered set for 2" "ES" grooving would be supplied with one (1) 2" "ES" tool bit mounted in tool and one (1) extra 2" "ES" tool bit wired to the tool.

TOOL NOMENCLATURE

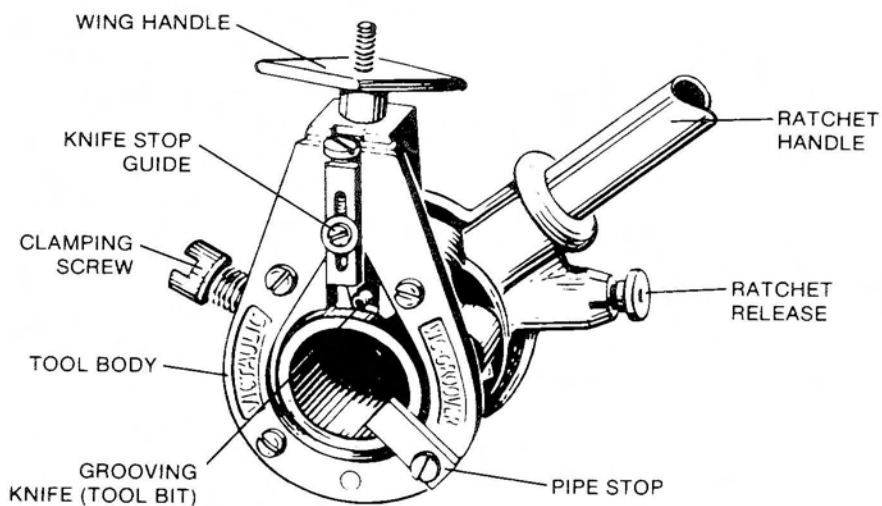

PIPE VISE SETUP

(Not applicable to pipe lathe grooving with a Vic-Groover.)

Vic-Groovers are designed for field or shop use. The choice of grooving location in the shop or field should take into account the following factors:

- Pipe handling requirements.
- Power requirements of the mule or power drive, if used.
- Working space requirements for the operator, tool, and power drive, if used.
- Anchoring requirements of the pipe vise.
- Anchoring requirements of power drive, if used.

PROCEDURE

1. Securely mount pipe vise on a secure stand or workbench. Pipe vise should be mounted flush with, or overhang, the edge of the stand or workbench so that, when the tool is mounted on the pipe, the tool will rotate freely around the pipe and not be obstructed by the bench or stand. Securely fasten stand or workbench to floor.

CAUTION: Failure to attach pipe vise securely to stand or bench, failure to attach stand securely to floor or failure to operate power drive in accordance with manufacturer's instructions, may result in serious personal injury.

PIPE PREPARATION

For best results the following preparation tips must be carefully observed:

1. Pipe ends must be "square cut", see pipe preparation specifications. **NOTE:** It continues to be Victaulic's first recommendation that pipe be square cut. Beveled pipe may be used provided the wall thickness is standard wall (ANSI B36.10) or less and the bevel meets ANSI B16.25 (37½"). Square cut pipe **must** be used with Flush-Seal® and EndSeal® gaskets. Gasket seat "A" is measured from the end of the pipe.
2. Any external weld beads or seams must be ground smooth and flush with the pipe surface, back 2" from the pipe end.

MOUNTING THE PIPE FOR GROOVING

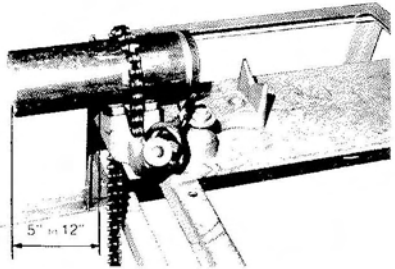

FOR STATIONARY PIPE (DRIVEN TOOL) ONLY:

1. Secure pipe in standard pipe vise anchored to hold securely the pipe plus the weight of the tool. (See Operating Data Table on Page 21 for Tool Weights.) See Pipe Vise Setup. Position the pipe to overhang the pipe vise approximately 5" tp 12" as shown, so that the tool can groove the pipe without hitting the pipe vise, pipe vise stand, or bench. Use an overhang of 9" to 16" for the VG-46 Adjustable Vic-Groover.

FOR STATIONARY TOOL (DRIVEN PIPE) ONLY:

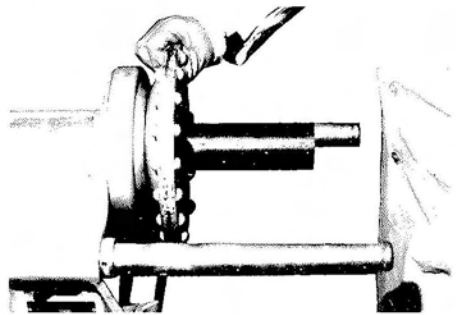

1. Chuck pipe securely in a power drive or pipe lathe in accordance with manufacturer's instructions, as shown. Pipe must overhang chuck approximately 5" to 12" so that the tool will fit fully onto the pipe. Use an overhang of 9" to 16" for the VG-46 Adjustable Vic-Groover.

IMPORTANT: Power drive or pipe lathe must turn pipe at or below the tool's maximum recommended speed. See Operating Data Table on Page 21.

MOUNTING OF TOOL ON PIPE

Procedures shown in the following photos are for the VG-4, procedures are similar for all other Vic-Groover sizes.

1. Check and make certain proper tool bit is installed for the type of grooving required.
2. Check and make certain proper pipe stops are installed for type of grooving required. VG-46 ONLY: Adjust tool to the correct pipe size. Remove roller carrier positioning screws and adjust carriers to the desired pipe size. Reinstall the positioning screws. Remove the knife carrier mounting screws and adjust carrier to desired size. Reinstall mounting screws.
3. Before mounting tool, fully retract tool bit by turning wing handle fully clockwise. Retract clamp screw far enough to clear the pipe by turning counterclockwise.

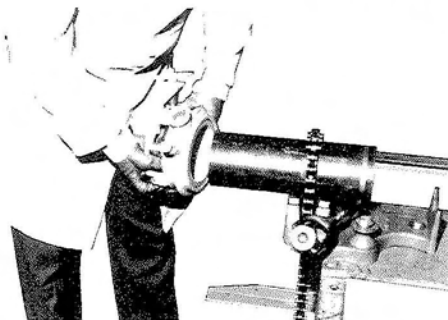

4. Lift tool and mount it on the pipe end manually as shown. Wing handle should be facing **UPWARD**.

NOTE: Exercise caution to prevent tool bit from hitting the pipe during mounting.



5. Hold tool firmly against pipe end, making sure the pipe stop(s) are in flush contact with the pipe end. Manually tighten

the clamp screw (clockwise), bringing the external support rolls into contact with the outside pipe surface. Load the clamp screw against the pipe by hand. Tighten to approximately 5 - 10 ft. lbs. Use 15 - 20 ft. lbs. for 4" to 6" Adjustable Vic-Groover clamp assemblies using the notches as a guide to center the tool.

CAUTION: Do not overtighten clamping screw(s) as damage to the pipe or the tool may result. This is extremely important when the tool is used on gray cast iron pipe or glass lined pipe as these materials are relatively brittle and may crack. If the clamping screw(s) are not tightened sufficiently, the tool may not "track" properly and thus not groove properly.

ATTACHING POWER DRIVE

(IF TOOL IS TO BE POWER DRIVEN)

Vic-Groovers can be driven with properly operated power mules, free-standing power vises or other power sources in conjunction with a secure pipe support system. All types of power sources should only be used after their power, speed, and safety requirements have been met. The power drive manufacturer's instructions should always be followed prior to operating their equipment. **CAUTION:** All power drives must be equipped to operate with instantaneous release electrical switching device (i.e.; foot switch or constant pressure hand switch).

Vic-Groovers must be driven at speeds equal to or less than their recommended speeds under load. See Operating Data Table on Page 21 for maximum under load speeds. Should your power drive run too fast, tool bit chatter may result. Use of a speed control reducer is recommended to reduce your power drive speed. See Page 21 for more information.

NOTE: 3/4" to 1 1/2" Vic-Groovers are not supplied with a power yoke as standard. A power yoke is required for power operation, and must be ordered separately from the Victaulic Tool Company.

IMPORTANT:

PRIOR TO ATTACHING THE POWER DRIVE, REMOVE RATCHET HANDLE. Set the ratchet release to the engaged position to prevent the ratchet housing from sliding off the tool during operation.

PROCEDURE, MULE ONLY:

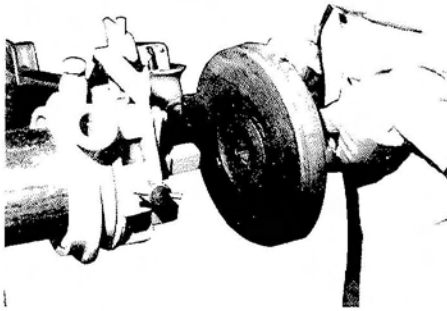

IMPORTANT: READ AND UNDERSTAND MULE OPERATING INSTRUCTIONS.

1. Align the square hole in the mule head with the 1" square drive on the tool and slide the mule head onto the tool as shown. Make sure mule is positioned 90° to the pipe centerline.

PROCEDURE, SELF-STANDING TYPE POWER DRIVE ONLY:

RIDGID® SHOWN, OTHER BRANDS SIMILAR

IMPORTANT: READ AND UNDERSTAND POWER DRIVE OPERATING INSTRUCTIONS

1. Position the Power Drive far enough away from the pipe so that the universal shaft will fit properly between the Power Drive and tool. See Figures 1 and 2. Position of power drive must allow universal shaft to operate freely without binding at the universal joints. Consult manufacturer's instructions before using shaft.
2. Mount the chuck end of universal shaft (Ridgid® 840 shown) into power drive chuck. Securely tighten chuck. Others similar.

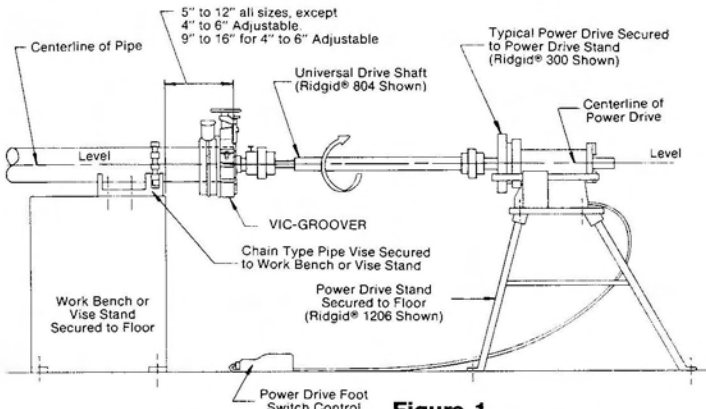

Figure 1
RIDGID® 300 TYPE POWER DRIVE SETUP (Side View)

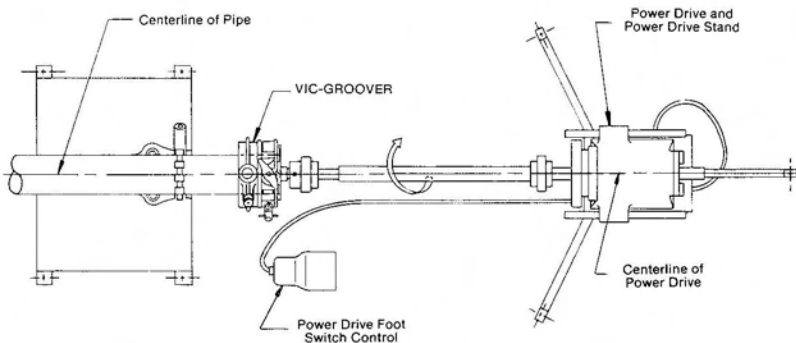
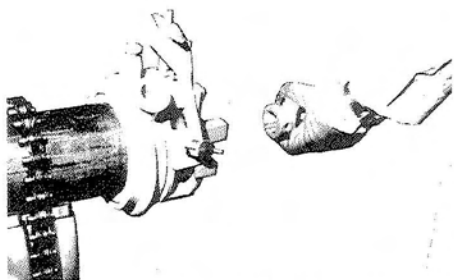

Figure 2
RIDGID® 300 TYPE POWER DRIVE SETUP (Top View)



3. Retract the universal shaft far enough to fit the square hole end (tool end) of the shaft onto the 1" square drive of the tool. Slide the universal shaft end over the 1" square drive of the tool as shown and securely tighten the universal shaft set screw to securely hold the universal shaft on the tool.

Make sure the universal shaft is not extended further than the manufacturer's recommendation. Follow manufacturer's lubrication instructions.

4. SECURELY FASTEN POWER DRIVE TO FLOOR

WARNING: Failure to operate power drive in accordance with manufacturer's instructions may result in serious personal injury due to torque reactions.

POWER DRIVE-POWER HOOKUP

IMPORTANT: READ AND UNDERSTAND POWER DRIVE OPERATING INSTRUCTIONS

Mules are designed to operate on 115 volt 15 amp AC power of any cycle. Plug mule into an appropriate outlet. If using an extension cord, see recommended cord sizes on Page 10. **Always plug mule into an internally grounded outlet. Mule must be grounded.**

Most self-standing power drives are designed to operate on a 115 volt 50/60 Hz 15 amp circuit. Plug power drive into an appropriate outlet. If using an extension cord, see recommended cord sizes below. Power drive must be controlled with a foot switch or instantaneous release switch for safe operation. If your power drive is not so equipped, use a Ridgid® 301 type foot

switch or equivalent between power drive plug and outlet. **Always plug power drive in an internally grounded outlet. Power drive must be grounded.**

If you are using a Speed Control Reducer, plug speed reducer into an appropriate outlet and plug power drive into the Speed Control Reducer. The Speed Control Reducer, available through Victaulic is designed to operate on a 115 volt \$5 amp 50/60Hz power supply. If using an extension cord, see recommended cord sizes on Page 10. **ALWAYS PLUG SPEED CONTROL REDUCERS INTO AN INTERNALLY GROUNDED OUTLET. SPEED CONTROL REDUCER MUST BE GROUNDED.**

NOTE: The Speed Control Reducers available from Victaulic **only** work with AC universal motors. Mules and most power drives have universal motors. **DO NOT USE SPEED CONTROL REDUCER WITH INDUCTION TYPE AC MOTORS AS DAMAGE TO MOTOR AND SPEED CONTROL MAY RESULT.**

EXTENSION CORD REQUIREMENTS

When prewired outlets are not available and an extension cord must be used, it is important to use the proper cord size (e.g., conductor size American Wire Gage). Cord size selection is based upon tool rating (amps) and cord length (ft.). Use of a cord size (gage) thinner than that required will cause a significant voltage drop at the tool while the tool is operating. The voltage drop may damage the tool and can result in failure of the tool to operate properly. Use of a heavier than necessary cord size (gage) is acceptable.

Listed in the chart on Page 10 are recommended cord sizes (gage) for cord lengths up to and including 100 feet. Use of extension cords beyond 100 feet in length should be avoided. For Power Drives not listed, consult manufacturer for recommendation.

**RECOMMENDED EXTENSION CORD CONDUCTOR SIZE
(AWG) AT VARIOUS CORD LENGTHS (FT.)**

POWER DRIVE	TOOL RATINGS VOLTS/ AMPS	CORD LENGTHS		
		25 FEET	50 FEET	100 FEET
MULE	115/15	12	12	10
RIDGID® 300	115/15	12	12	10
OSTER® 310	115/15	12	12	10
LSCR (Speed Control Reducer)	115/15	12	12	10

ADJUSTING THE GROOVE DIAMETER

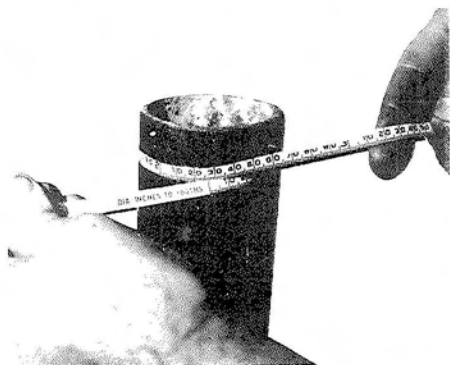

1. Prepare a trial groove and dismount tool. See grooving operation and dismounting tool. Carefully measure the groove diameter. Groove diameter is best checked with a pi-tape, as shown. It may also be checked with a vernier caliper or Narrow land micrometer at two locations 90° apart, around the groove. Average reading must equal the required groove diameter. For required groove diameters, refer to groove specifications on Page 22.

NOTE: The "C" dimension, groove diameter, must always conform to specifications listed under "Groove Specifications", Page 22.

2. If groove diameter ("C" dimension) is not within specification, the groove diameter stop must be adjusted to obtain the proper dimension. Proceed as follows:

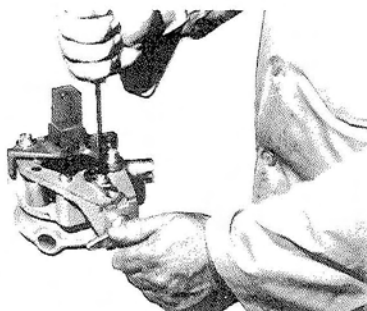

- 3-A. On ¾" to 4" and 3" CI Vic-Groovers inclusive, loosen locking screw as shown.

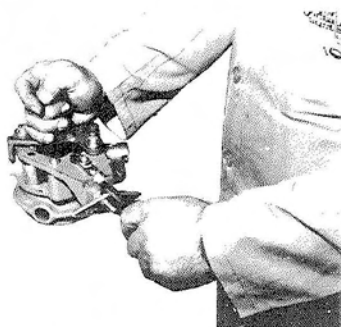

With a straight blade screwdriver, adjust the groove diameter as shown. One full turn of the adjusting screw changes the groove diameter 0.100". Looking at the top side of the tool, turn the adjusting screw clockwise to increase groove diameter (decrease groove depth). Turn the adjusting screw counterclockwise to decrease the groove diameter (increase groove depth).

Tighten the locking screw.

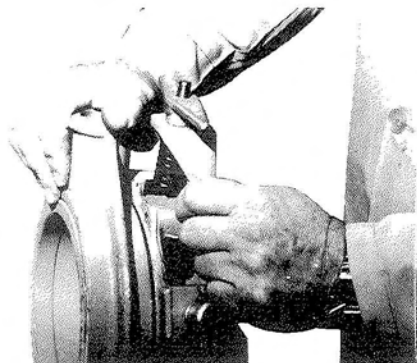

3-B. On 5", 6", 4" CI, and 6" CI Vic-Groovers, loosen locking set screw several turns with hex key, supplied, as shown.

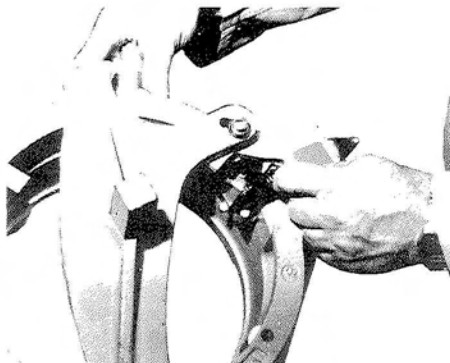

3-C. On 8" and 4" to 6" adjustable Vic-Groovers loosen locking set screw with hex key, supplied, as shown.

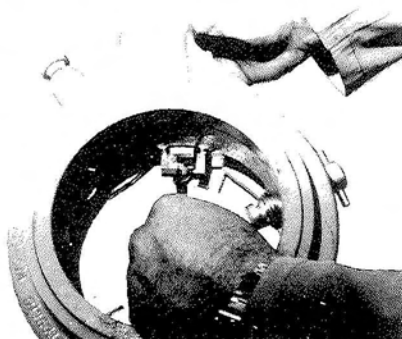

With $\frac{1}{4}$ " open end wrench, supplied, adjust the groove diameter stop as shown. One full turn of the adjusting screw changes the groove diameter 0.063". Looking at the inside of the tool, turn the adjusting screw clockwise to decrease groove diameter (increase groove depth). Turn the adjusting screw counterclockwise to increase the groove diameter (decrease groove depth).

Tighten the locking set screw.

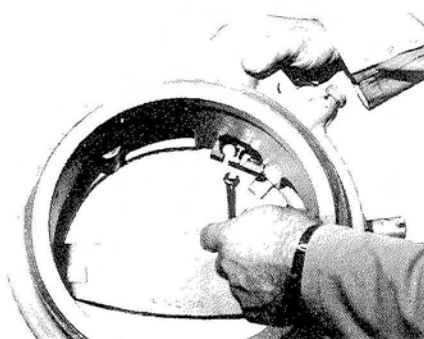

With $\frac{1}{4}$ " open end wrench, supplied, adjust the groove diameter stop as shown. One full turn of the adjusting screw changes the groove diameter 0.100". Looking at the inside of the tool, turn the adjusting screw clockwise to decrease groove diameter (increase groove depth). Turn the adjusting screw counterclockwise to increase the groove diameter (decrease groove depth).

Tighten the locking set screw.

4. If original groove diameter was oversize, complete the groove and recheck the groove diameter. If original groove diameter was undersize, prepare another trial groove and check diameter.
5. Repeat Steps 3 through 4 until groove diameter is within specification.

GROOVING

1. If tool is power driven, set control switch on power drive to produce clockwise rotation of tool, forward on most power drives. **MAKE SURE RATCHET HANDLE IS REMOVED.**

If manually driven, engage ratchet pin so that the tool's ratchet handle produces clockwise rotation of the tool.

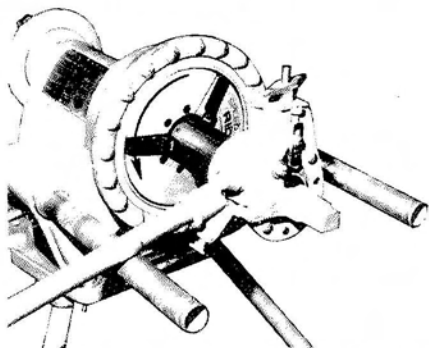

If pipe is power drive or pipe lathe driven, position Vic-Groover ratchet handle to rest on support, as shown. Engage ratchet pin so that when the pipe is turned in the direction shown, the ratchet mechanism locks the tool.

2. Check Direction of Tool:

If power driven, start rotation by momentarily depressing power drive foot switch. Proper direction of tool is **CLOCKWISE** when viewed from 1" square drive side of tool.

If tool direction is clockwise, proceed with next step. If counterclockwise, flip power drive control switch to the opposite direction. Retest tool direction and make sure tool rotates clockwise.

If manually driven, pull ratchet handle in the **CLOCKWISE** direction. Tool should rotate clockwise. If tool "ratchets" when handle is pulled, retract ratchet pin and turn it to the opposite position (rotate 180°) and re-engage. Retest tool direction and make sure tool rotates **CLOCKWISE**.

If pipe is driven, start pipe rotation counterclockwise when viewed from the tool end of the pipe. If tool "ratchets", retract pin and turn it to the opposite position (rotate 180°) and re-engage. Retest and make sure ratchet is engaged.

WARNING: Never attempt to rotate tool counterclockwise (or drive pipe clockwise) as tool may come off the end of the pipe and result in personal injury.

3. Check Tool Stability on Pipe:

If tool is power or manually driven, drive the tool in a clockwise direction for several revolutions and observe the stability of the tool. The tool should rotate around the pipe smoothly without slipping. If the tool does not rotate smoothly, tighten the clamp screw an additional $\frac{1}{8}$ turn. Retest tool for stability and continue to tighten clamp screw as needed.

If pipe is driven, drive pipe in a counterclockwise direction for several revolutions and observe the stability of the tool. The tool should remain stable without vibrating. If tool does not remain stable, tighten the clamp screw an additional $\frac{1}{8}$ turn. Retest and continue to tighten clamp screw as needed.

NOTE: Do not tighten clamp screw beyond what is needed to rotate the tool smoothly. Overtightening may result in damage to the tool or may crack brittle materials.

4. If tool is driven, drive the tool in a **CLOCKWISE** direction and stop it with the wing handle facing **UPWARD**.

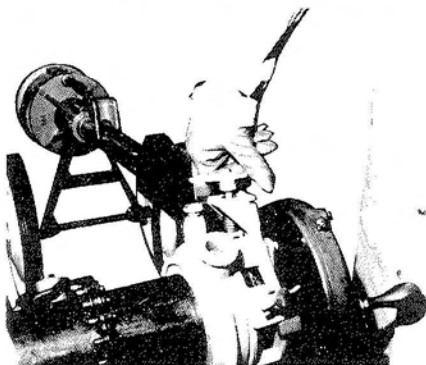

5. Back off the wing handle counterclockwise, which will spring load the tool bit against the pipe. Back it off so that it is at least $\frac{1}{8}$ " away from the top surface of the tool. Do not remove wing handle.

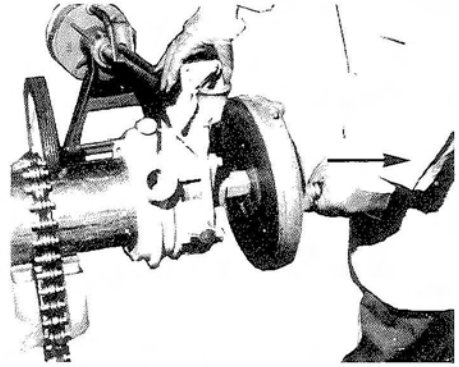
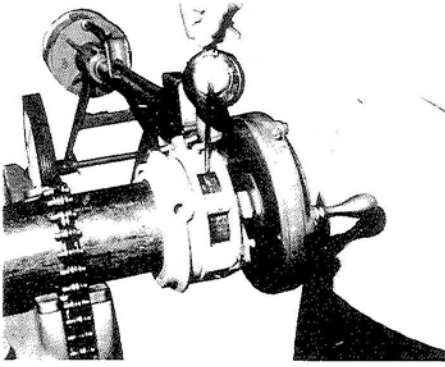

6. If tool is driven, drive the tool clockwise. If pipe is driven, drive pipe counterclockwise. As the tool or pipe rotates, generously oil the groove as shown with a good grade cutting oil (Ridgid® dark thread cutting oil or equal). Use a squirt-type oiler for best results.

NOTE: Only oil steel, aluminum and stainless steel pipe. Do not oil cast iron (gray or Ductile) pipe.

7. Continue grooving and oiling until groove is complete. Groove is complete when tool bit stops removing material around entire circumference of pipe. Indications of a complete groove or nearly complete groove are:

- Oil lying in the bottom of the groove after the tool bit passes
- The power drive picks up speed or ratcheting effort is greatly reduced.
- Chips stop falling from the tool, and
- On VG-46 adjustable, VG-5 and larger, VG-4CI and VG-6CI, the groove depth stop lightly grazes the pipe directly behind the groove.

NOTE: Some portions of the groove will be complete before others. Make sure entire groove is complete before dismantling tool.

DISMOUNTING TOOL

- If tool is driven, stop the tool with the wing handle facing **UPWARD**.
- Fully retract tool bit by turning wing handle **CLOCKWISE**, fully compressing the spring.
- Disconnect power drive, if used.

- **MULE ONLY** — Set the mule switch to turn the tool counterclockwise (reverse position). Gently pull on the mule handle as shown. While pulling on the handle, momentarily depress foot switch. The mule should slip off the tool as soon as the foot switch is depressed. Move (roll) the mule to the right to allow dismantling of the tool. Mule should rest on its two wheels and on the back end of motor.

- **SELF-STANDING TYPE POWER DRIVE** — Loosen the universal shaft set screw. Slide the tool end of the universal shaft off the tool. Position the universal shaft out of the way.

- Loosen the clamp screw so that the external support rolls no longer contact the pipe.
- Slide the tool off the pipe and set it on a workbench or the floor.
- With a rag, wipe any oil or chips off the pipe end. Groove diameter should be correct from the groove diameter adjustment procedure. Groove diameter should be checked periodically to make sure it is within specification.

TOOL MAINTENANCE

When Vic-Groovers are used for grooving steel, aluminum, or stainless steel pipe, the required cutting oil used during grooving thoroughly lubricates the tool. Thus, no regular lubrication is required.

Models 3CI, 4CI, and 6CI should be lubricated daily. Lightly oil the tool's moving parts, support rolls, tool bit guide, wing handle threads, ratchet release mechanism, clamping screw threads, and ratchet housing journal. Use a medium weight machine or motor oil.

TOOL BIT CHANGES

Once a tool bit has become dull or chipped, it must be replaced or resharpened.

TOOL BIT REMOVAL:

$\frac{3}{4}$ " through 4" and 3" CI Vic-Groovers

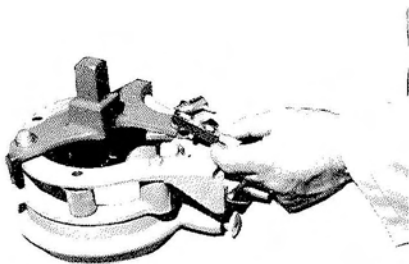

1. Remove the locking screw and knife stop guide as shown.
2. Fully back off wing handle, releasing all spring pressure.

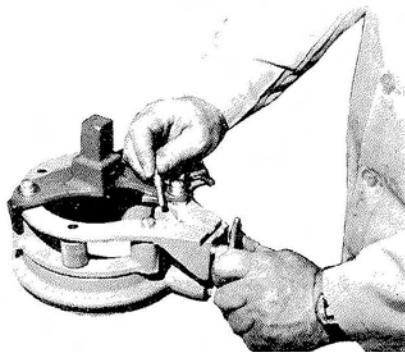

3. Pull out the tool bit stop, freeing the tool bit, and remove bit. On $\frac{3}{4}$ " and 1" tools remove the pipe end stop and tool bit holder. Pull tool bit out of its slot from the outside of the tool.

5", 6", 4" CI and 6" CI Vic-Groovers

1. Fully back off wing handle, releasing all spring pressure.

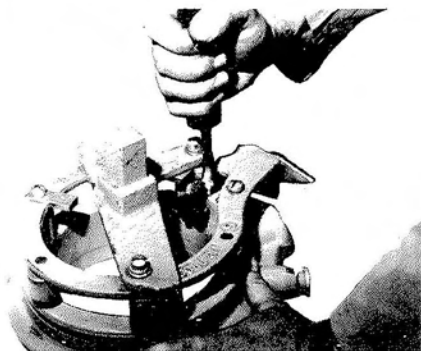

2. Remove tool bit screw, freeing tool bit. Remove bit.

4" to 6" adjustable and 8" Vic-Groovers



1. Remove wing handle and withdraw tool bit holder assembly from tool.

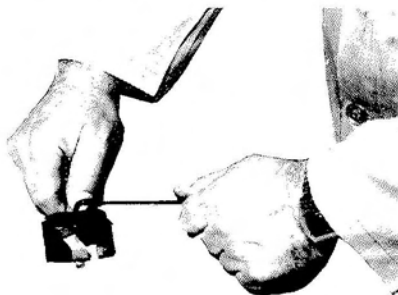

2. Loosen the two socket head screws with hex key and slide out tool bit.

TOOL BIT INSTALLATION:

3/4" through 4" and 3" CI Vic-Groovers

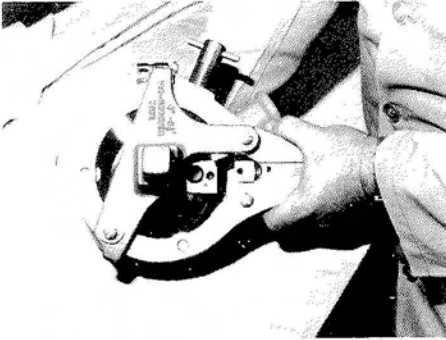

1. Fit new or resharpened tool bit into the body guide slot and tool bit holder. The side of the tool bit with markings must face the front (square drive side) of the tool. On 3/4" and 1" tools, insert tool bit from outside of tool and install knife holder with spring.
2. Insert the tool bit stop and tighten down on the wing handle, fully compressing the spring.
3. Install the tool bit stop guide with the chamfered end facing inward and install the locking screw and washer. On 3/4" and 1" tools, install the pipe end stop.
4. Proceed with groove diameter adjustment as detailed under "Adjusting The Groove Diameter".

5", 6", 4" CI and 6" CI Vic-Groovers

1. Fit new or resharpened tool bit into the body guide slot and tool bit holder. The side of the tool bit with markings must face the front (square drive side) of the tool.

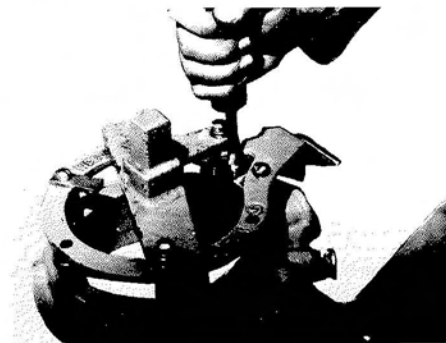

2. Install and tighten the tool bit screw. Tighten the swing handle fully, collapsing the spring.

3. Proceed with groove diameter adjustment as detailed under "Adjusting The Groove Diameter".

4" to 6" Adjustable and 8" Vic-Groovers

1. Install new or resharpened tool bit into tool bit holder. Finger tighten socket head screws.

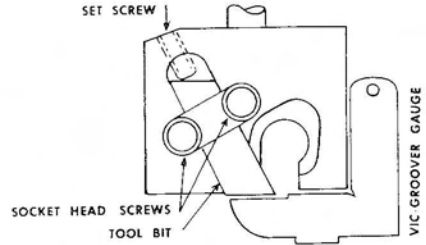

Figure 3

2. Hold correct size Vic-Groover gauge (supplied) in position shown in above Figure 3. With hex key fitted in set screw, adjust tool bit to lightly contact gauge. The gauge is notched to provide the correct tool bit projection. Should you not have a gauge, the correct projections are .010" for VG-46 and .003" for VG-8, as shown in above figure.
3. Securely tighten socket cap screws.
4. Install tool bit holder assembly into tool. Install and tighten wing handle fully, collapsing spring.
5. Proceed with groove diameter adjustment as detailed under "Adjusting The Groove Diameter".

RESHARPENING TOOL BITS

Only standard and ES tool bits may be resharpened. Tool bits for grooving stainless steel, plastic, and cast iron should not be resharpened.

Procedure:

1. Remove tool bit from tool, see "Tool Bit Removal".

2. Sharpen edge(s) of tool bit to specification. See Figure 4, below.

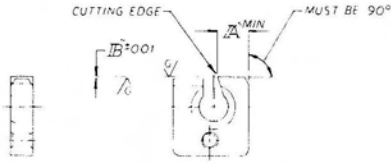

Size	"A"	"B"
3/4" thru 3"	.552	.017
3 1/2" and 4"	.490	.017
5" and 6"	.490	.010

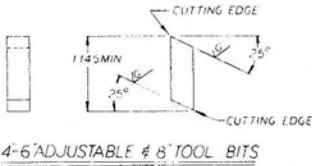

Figure 4

Resharpener Instructions:

Regrind "G" surfaces to obtain sharp cutting edges free of nicks and discoloration. If minimum dimensions shown cannot be maintained, tool bit must be discarded.

3. Install tool bit into tool. See "Tool Bit Installation". On 4"-6" Adjustable and 8" Vic-Groovers, see "Tool Bit Projection Adjustment".

TROUBLE SHOOTING

PROBLEM	POSSIBLE CAUSE	SOLUTION
Tool will not fit on pipe end.	<ol style="list-style-type: none"> 1. Clamping screw not retracted sufficiently. 2. Tool bit not retracted sufficiently. 3. On VG-46 adjustable, tool is set to the wrong pipe size. 4. Pipe does not overhang pipe vise or stand sufficiently. 	<ol style="list-style-type: none"> 1. Back off clamping screw far enough to clear pipe. 2. Turn wing handle clockwise, fully collapsing spring. 3. Adjust tool to correct size. See "Mounting Tool On Pipe". 4. Remount pipe to overhang pipe vise and stand as detailed under "Mounting The Pipe".
Tool will not rotate.	<ol style="list-style-type: none"> 1. When manually driven, ratchet release is not engaged or is engaged opposite the correct position. 2. Chips have become wedged between the support rolls and pipe. 3. Power drive is not plugged in (if used). 4. Power drive switch is in the "OFF" position. 5. On manually driven tools, ratchet release is worn out. 6. Clamping screw is too tight. 7. Pipe has a pronounced external weld seam. 8. Pipe end is oval out of Victaulic specification. 	<ol style="list-style-type: none"> 1. Ratchet release must be engaged to produce clockwise tool rotation. See "Grooving". 2. Dismount tool from pipe and clear away the chips from the tool and pipe end. 3. Plug power drive in. See power drive power hook up. 4. Move switch to the position to produce clockwise rotation of the tool. 5. Disassemble ratchet release assembly, and repair. 6. Loosen clamping screw and HAND tighten. 7. Dismount tool and grind weld seam down to be flush with pipe surface. See "Pipe Preparation." 8. Take steps to round up the pipe end or cut end off, removing oval section.

TROUBLE SHOOTING		
PROBLEM	POSSIBLE CAUSE	SOLUTION
Tool will not cut.	<ol style="list-style-type: none"> 1. The tool is being driven counterclockwise or pipe is being driven clockwise. 2. Tool bit not loaded against pipe properly. 3. Tool bit is dull. 4. Tool bit is installed backwards. 5. On VG-8 or VG-46 Adjustable, Tool Bit Projection is incorrect. 6. Chips have built up in tool bit. 	<ol style="list-style-type: none"> 1. On power driven tools; reverse power drive control switch and drive tool in the clockwise direction. On manually driven tools; move ratchet release to the opposite position and operate the tool in the clockwise direction. With power driven pipe; reverse direction of pipe rotation. It should be counterclockwise when viewed from the tool end. 2. Wing handle not backed off far enough to fully unload spring. See "Grooving". 3. Replace or sharpen tool bit. 4. See "Tool Bit Removal and Installation". 5. See "Tool Bit Projection Adjustment". 6. Dislodge chips from tool bit.
Tool chatters when cutting.	<ol style="list-style-type: none"> 1. Power drive or pipe running at a speed beyond tool's capacity. 2. Not enough cutting oil is being used. 3. The clamping screw is not tight enough. 4. Tool bit is starting to dull. 	<ol style="list-style-type: none"> 1. See "Attaching Power Drive". 2. See "Grooving". 3. See "Mounting The Tool On The Pipe". 4. Replace or sharpen tool bit.

TROUBLE SHOOTING

PROBLEM	POSSIBLE CAUSE	SOLUTION
<p>Tool will nut "hug" pipe end</p>	<ol style="list-style-type: none"> 1. Tool being driven counterclockwise or pipe being driven clockwise. 2. Mule, if used, is not positioned 90° to pipe. 3. Clamping screw is not tight enough. 	<ol style="list-style-type: none"> 1. On power driven tools; reverse power drive control switch and drive tool in the clockwise direction. On manually driven tools; move ratchet release to the opposite position and operate the tool in the clockwise direction. With power driven pipe; reverse direction of pipe rotation. It should be counterclockwise when viewed from the tool end. 2. See "Attaching Power Drive". 3. See "Mounting The Tool On The Pipe".
<p>Tool cannot be dismantled from pipe.</p>	<ol style="list-style-type: none"> 1. Clamping screw is not loosened. 2. Tool bit not retracted. 	<ol style="list-style-type: none"> 1. Loosen clamping screw by turning counterclockwise. 2. Turn wing nut clockwise fully collapsing spring.
<p>Groove Diameter ("C" Dimension) incorrect.</p>	<ol style="list-style-type: none"> 1. Depth stop out of adjustment. 2. On VG-8 and VG-46 tools, tool bit projection is out of adjustment. 3. Pipe O.D. varies widely from piece to piece. 4. Chips have built up in tool bit or tool bit holder. 	<ol style="list-style-type: none"> 1. See "Adjusting Groove Diameter". 2. See "Tool Bit Projection Adjustment". 3. Groove diameter adjustment must be made for each piece to assure correct groove diameter. 4. Retract tool bit, clear chips, and continue grooving.

(continued)

TROUBLE SHOOTING		
PROBLEM	POSSIBLE CAUSE	SOLUTION
Groove Diameter ("C" Dimension) incorrect (continued)	<ol style="list-style-type: none"> 5. Tool bit has been resharpened beyond specified limits. 6. Depth stop has worn to a point where it can no longer be adjusted. 	<ol style="list-style-type: none"> 5. Replace tool bit. 6. Replace worn depth stop.
Gasket Seat ("A" Dimension) incorrect	<ol style="list-style-type: none"> 1. Wrong tool bit or pipe stops installed in tool. 2. Pipe stop(s) worn. 3. Pipe not square cut. 4. Mule, if used, not positioned 90° to pipe. 5. On VG-46 Adjustable, tool is not fully seated onto pipe. 	<ol style="list-style-type: none"> 1. See "Tool Bit/Pipe Stop Specification Chart". 2. Replace pipe stop(s). 3. Square cut pipe. See "Grooving Specifications". 4. See "Attaching Power Drive". 5. Loosen clamping screws and push tool fully onto pipe up against pipe stops. Retighten clamping screws.
Groove Width ("B" Dimension) incorrect.	<ol style="list-style-type: none"> 1. Wrong tool bit installed in tool. 2. Mule, if used, not positioned 90° to pipe. 	<ol style="list-style-type: none"> 1. See "Tool Bit/Pipe Stops Specification Chart". 2. See "Attaching Power Drive".

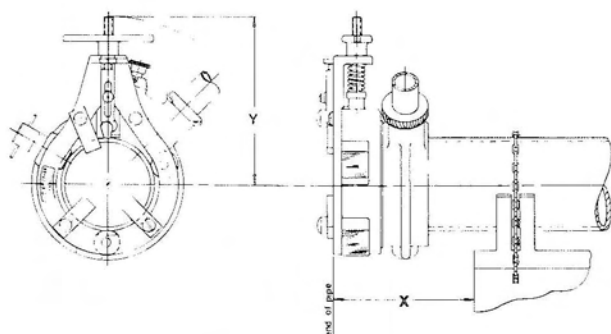

OPERATING DATA				
VIC-GROOVER SIZE	WEIGHT LBS.	X INCHES	Y INCHES	MAX. SPEED (under load) RPM
3/4	11	3 7/8	5 3/8 R	40
1	11	3 5/8	5 3/8 R	40
1 1/4	12	3 7/8	6 3/8 R	40
1 1/2	12	3 7/8	6 3/8 R	40
2	12	3 3/4	6 3/8 R	30
2 1/2	16	3 7/8	6 5/8 R	30
3	16	3 3/4	6 5/8 R	30
3 1/2	18	3 7/8	7 3/8 R	30
4	18	3 3/4	7 3/8 R	30
5	25	3 3/4	7 1/2 R	30
6	25	3 3/4	8 1/4 R	22
8	45	4 3/8	9 1/2 R	22
4 to 6 ADJ	50	7 11/16	8 5/8 R	22
3 Cl	20	3 7/8	7 3/8 R	30
4 Cl	26	3 7/8	7 1/2 R	30
6 Cl	27	3 3/4	8 1/4 R	22

GROOVING TOOL ACCESSORIES

The following power accessories are available for rental or sale in conjunction with Victaulic Vic-Groovers to assure proper performance and use of the Tool.

POWER MULES

Power Mules provide an ideal portable power source and are geared for proper speed for grooving. Mules are provided with foot pedal control for ease and safety of operation (115V, 15 amp AC).

SPEED REDUCTION CONTROL

For electrical speed reduction on various available universal power drive sources, a Speed Control unit (115V, 15 amp AC) is available to provide proper maximum Grooving Tool rotation speed (rpm). This speed control plugs in between the electrical supply and the power drive electrical plug permitting proper speed adjustment. A speed control is not required with the above Power Mule. **DO NOT USE WITH INDUCTION-TYPE MOTORS.**

TOOL BIT/PIPE STOP SELECTION CHART

Tool/Pipe Size	Gasket Seat "A"	Groove Width "B"	Pipe End Stops		Grooving Knife Part Number	Feed Spring Part Number
			Req'd.	Part Number		
STEEL ALUMINUM — IPS — STANDARD GROOVE						
3/4, 1, 1 1/4, 1 1/2, 2	0.625	0.312	1	R-005-003-OVG	R-008-003-OVG	R-015-003-OVG
2 1/2, 3	0.625	0.312	3	R-005-003-OVG	R-008-005-OVG	R-015-003-OVG
3 1/2, 4	0.625	0.375	3	R-005-003-OVG	R-008-014-OVG	R-015-003-OVG
5,6	0.625	0.375	3	R-005-003-OVG	R-008-020-OVG	R-015-020-OVG
4-6 ADJ.	0.625	0.375	3	R-005-046-AVG	R-030-046-AVG	R-015-020-OVG
8	0.750	0.437	3	R-005-003-OVG	R-030-032-OVG	R-015-003-OVG
STEEL, ALUMINUM — IPS — ES GROOVE						
2	0.562	0.255	1	R-063-008-OVG	R-064-008-OVG	R-015-003-OVG
2 1/2, 3	0.562	0.255	2	R-063-008-OVG	R-064-008-OVG	R-015-003-OVG
			1	R-065-010-OVG		
4	0.605	0.305	2	R-063-016-OVG	R-064-016-OVG	R-015-003-OVG
			1	R-065-016-OVG		
6	0.605	0.305	2	R-063-016-OVG	R-064-024-OVG	R-015-020-OVG
			1	R-065-016-OVG		
8	0.714	0.400	2	R-063-032-OVG	R-064-032-OVG	R-015-003-OVG
			1	R-065-032-OVG		
STAINLESS STEEL, TYPES 304, 316 — IPS — STANDARD GROOVE						
3/4, 1	0.625	0.312	1	R-005-003-OVG	R-066-003-OVG	R-015-003-OVG
1 1/4, 1 1/2, 2	0.625	0.312	1	R-005-003-OVG	R-066-005-OVG	R-015-003-OVG
2 1/2, 3	0.625	0.312	3	R-005-003-OVG	R-066-005-OVG	R-015-003-OVG
3 1/2, 4	0.625	0.375	3	R-005-003-OVG	R-066-014-OVG	R-015-003-OVG
5, 6	0.625	0.375	3	R-005-003-OVG	R-066-020-OVG	R-015-020-OVG
4-6 ADJ.	0.625	0.375	3	R-005-046-AVG	R-066-046-AVG	R-015-020-OVG
8	0.750	0.437	3	R-005-003-OVG	R-006-032-OVG	R-015-003-OVG
PVC PLASTIC — IPS — STANDARD GROOVE						
3/4, 1, 1 1/4, 1 1/2, 2	0.625	0.312	1	R-005-003-OVG	R-067-003-OVG	R-068-003-OVG
2 1/2, 3	0.625	0.312	3	R-005-003-OVG	R-067-005-OVG	R-068-003-OVG
3 1/2, 4	0.625	0.375	3	R-005-003-OVG	R-067-014-OVG	R-068-003-OVG
5, 6	0.625	0.375	3	R-005-003-OVG	R-067-020-OVG	R-068-003-OVG
4-6 ADJ.	0.625	0.375	3	R-005-046-AVG	R-067-046-AVG	R-068-003-OVG
8	0.750	0.437	3	R-005-003-OVG	R-067-032-OVG	R-068-003-OVG
DUCTILE/CAST IRON — STANDARD GROOVE (RIGID)						
3CI, 4CI, 6CI	0.840	0.375	3	R-005-015-CVG	R-008-015-CVG	R-015-020-OVG
DUCTILE/CAST IRON — FLEXIBLE GROOVE						
3CI, 4CI, 6 CI	0.750	0.375	3	R-069-015-CVG	R-008-015-CVG	R-015-020-OVG

FOR STANDARD STEEL AND OTHER IPS PIPE

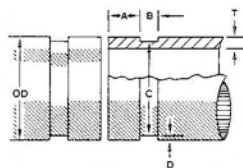

STANDARD CUT GROOVE SPECIFICATIONS STEEL AND OTHER METALLIC IPS PIPE

1 Nom. Pipe Size In.	2 Pipe Outside Diameter O.D.			3 Gasket Seat "A" ± 0.031	4 Groove Width "B" ± 0.031	5 Groove Diameter "C"		6 Groove Depth "D" Ref.	7 Min. Allow. Wall Thick. "T"
	Basic	+ Tolerance	-			Basic	Tol. +0.000		
3/4	1.050	+0.010	-0.010	0.625	0.313	0.938	-0.015	0.056	0.113
1	1.315	+0.013	-0.013	0.625	0.313	1.190	-0.015	0.062	0.133
1 1/4	1.660	+0.016	-0.016	0.625	0.313	1.535	-0.015	0.062	0.140
1 1/2	1.900	+0.019	-0.019	0.625	0.313	1.775	-0.015	0.062	0.145
2	2.375	+0.024	-0.024	0.625	0.313	2.250	-0.015	0.063	0.154
2 1/2	2.875	+0.029	-0.029	0.625	0.313	2.720	-0.018	0.078	0.188
3	3.500	+0.035	-0.031	0.625	0.313	3.344	-0.018	0.078	0.188
3 1/2	4.000	+0.040	-0.031	0.625	0.313	3.834	-0.020	0.083	0.188
4	4.500	+0.045	-0.031	0.625	0.375	4.334	-0.020	0.083	0.203
5	5.563	+0.056	-0.031	0.625	0.375	5.395	-0.022	0.084	0.203
6	6.625	+0.063	-0.031	0.625	0.375	6.455	-0.022	0.085	0.219
8	8.625	+0.063	-0.031	0.750	0.438	8.441	-0.025	0.092	0.238

"ES" CUT GROOVE SPECIFICATIONS STEEL AND OTHER METALLIC IPS PIPE

1 Nom. Pipe Size In.	2 Pipe Outside Diameter O.D.			3 Gasket Seat "A"	4 Groove Width "B"			5 Groove Dia. "C"		6 Groove Depth "D" Ref.	7 Min. Allow. Wall Thick. "T"
	Basic	+Tolerance	-		Basic	+0.010	-0.005	Basic	Tol. +0.000		
2	2.375	+0.024	-0.024	0.562 \pm 0.10	0.255	+0.010	-0.005	2.250	-0.015	0.062	0.154
2 1/2	2.875	+0.029	-0.029	0.562 \pm 0.10	0.255	+0.010	-0.005	2.720	-0.018	0.078	0.188
3	3.500	+0.035	-0.031	0.562 \pm 0.10	0.255	+0.010	-0.005	3.344	-0.018	0.078	0.188
4	4.500	+0.045	-0.031	0.605 \pm 0.015	0.305	+0.010	-0.005	4.334	-0.020	0.083	0.203
6	6.625	+0.063	-0.031	0.605 \pm 0.015	0.305	+0.010	-0.005	6.455	-0.022	0.085	0.219
8	8.625	+0.063	-0.031	0.714 \pm 0.015	0.400	+0.010	-0.010	8.441	-0.025	0.092	0.238

COLUMN 1 - NOMINAL IPS PIPE SIZE.

COLUMN 2 - IPS OUTSIDE DIAMETER: The outside diameter of cut grooved pipe shall not vary more than the tolerance listed. For IPS pipe, the maximum allowable tolerance from square cut ends is 0.030" for 3/4" thru 3 1/2", 0.045" for 4" thru 6", and 0.060" for sizes 8" O.D. and above measured from true square line.

COLUMN 3 - GASKET SEAT: The pipe surface shall be free from indentations and projections from the end of the pipe to the groove, to provide a leaktight seat for the gasket. All loose paint, scale, dirt, chips, grease, and rust must be removed. It continues to be Victaulic's first recommendation that pipe be square cut. Beveled pipe may be used provided the wall thickness is standard wall (ANSI B36.10) or less and the bevel meets ANSI B16.25 (37 1/2"). Square cut pipe must be used with FlushSeal® and EndSeal® gaskets. Gasket seat "A" is measured from the end of the pipe.

COLUMN 4 - GROOVE WIDTH: Bottom of groove to be free of loose dirt, chips, rust and scale that may interfere with proper coupling assembly. Maximum permissible radius at bottom of groove is .015" for standard grooves; 0.04" for "ES" grooves.

COLUMN 5 - GROOVE OUTSIDE DIAMETER: The groove must be of uniform depth for the entire pipe circumference. Groove must be maintained within the "C" diameter tolerance listed.

COLUMN 6 - GROOVE DEPTH: For reference only. Groove must conform to the groove diameter "C" listed.

COLUMN 7 - MINIMUM ALLOWABLE WALL THICKNESS: This is the minimum wall thickness which may be cut grooved.

FOR CAST PIPE (GRAY AND DUCTILE) OF AWWA DIMENSIONS

For cast pipe, the groove is cut with a radius at the corners of the groove base to reduce stress concentration. Standard preparation is with rigid radius groove. Flexible radius groove dimensions may be used to provide expansion, contraction or angular movement allowance at the joint.

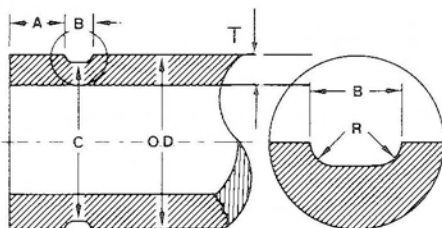

RIGID RADIUS CUT GROOVE SPECIFICATIONS

1 Nom. Pipe Size In.	2 Pipe Outside* Diameter—O.D.		3 Gasket Seat "A"	4 Groove Width "B"	5 Groove Diameter "C"		6 Radius "R"	7 Minimum Allowable Wall Thickness "T"	
	Basic	Tolerance	+0.000 -0.020	+0.031 -0.016	Basic	Tolerance +0.000		Cast Iron	Ductile Iron
3	3.96	±0.045	0.840	0.375	3.723	-0.020	0.120	0.32	0.31
4	4.80	±0.045	0.840	0.375	4.563	-0.020	0.120	0.35	0.32
6	6.90	±0.045	0.840	0.375	6.656	-0.020	0.120	0.38	0.34

FLEXIBLE RADIUS CUT GROOVE SPECIFICATIONS

1 Nom. Pipe Size In.	2 Pipe Outside* Diameter—O.D.		3 Gasket Seat "A"	4 Groove Width "B"	5 Groove Diameter "C"		6 Radius "R"	7 Minimum Allowable Wall Thickness "T"	
	Basic	Tolerance	+0.000 -0.020	+0.031 -0.016	Basic	Tolerance +0.000		Cast Iron	Ductile Iron
3	3.96	±0.045	0.840	0.375	3.723	-0.020	0.120	0.32	0.31
4	4.80	±0.045	0.840	0.375	4.563	-0.020	0.120	0.35	0.32
6	6.90	±0.045	0.840	0.375	6.656	-0.020	0.120	0.38	0.34

*Victaulic Flexible Joint Radius Groove Specifications for cast pipe (gray and ductile) conform to requirements of AWWA C-606. If rigid joints are required, refer to table above for proper groove dimensions.

COLUMN 1 - NOMINAL DUCTILE/CAST PIPE SIZE.

COLUMN 2 - DUCTILE/CAST OUTSIDE DIAMETER: The outside diameter of cut grooved pipe shall not vary more than the tolerance listed. For ductile/cast pipe, the maximum allowable tolerance from square cut ends is 0.030" for 3" and 0.045" for sizes 4" and 6" measured from true square line.

COLUMN 3 - GASKET SEAT: The pipe surface shall be free from indentations and projections from the end of the pipe to the groove, to provide a leaktight seat for the gasket. All loose paint, scale, dirt, chips, grease, and rust must be removed.

COLUMN 4 - GROOVE WIDTH: Bottom of groove to be free of loose dirt, chips, rust and scale that may interfere with proper coupling assembly.

COLUMN 5 - GROOVE OUTSIDE DIAMETER: The groove must be uniform depth for the entire pipe circumference. Groove must be maintained within the "C" diameter tolerance listed.

COLUMN 6 - GROOVE CORNER RADIUS

COLUMN 7 - MINIMUM ALLOWABLE WALL THICKNESS: This is the minimum wall thickness which may be cut grooved.

PARTS ORDERING INFORMATION

When ordering parts the following information is necessary for the Victaulic Tool Company to process the order and send the correct part(s).

- (1) Tool Model Number VG-(size). Example: VG-2".
- (2) Part Number, (Quantity), and Description.
For example: Part No. R-005-003-OVG, (1) Pipe End Stop
- (3) Where to send the part(s):
Company Name
Address
- (4) To whose attention to send the part(s):
Person's Name
- (5) Purchase Order Number.

Order parts from the nearest Victaulic Sales Office. Consult the back page of this instruction manual for the nearest Victaulic Sales Office.

PARTS DRAWING — VIC-GROOVERS — 3/4" THROUGH 8"

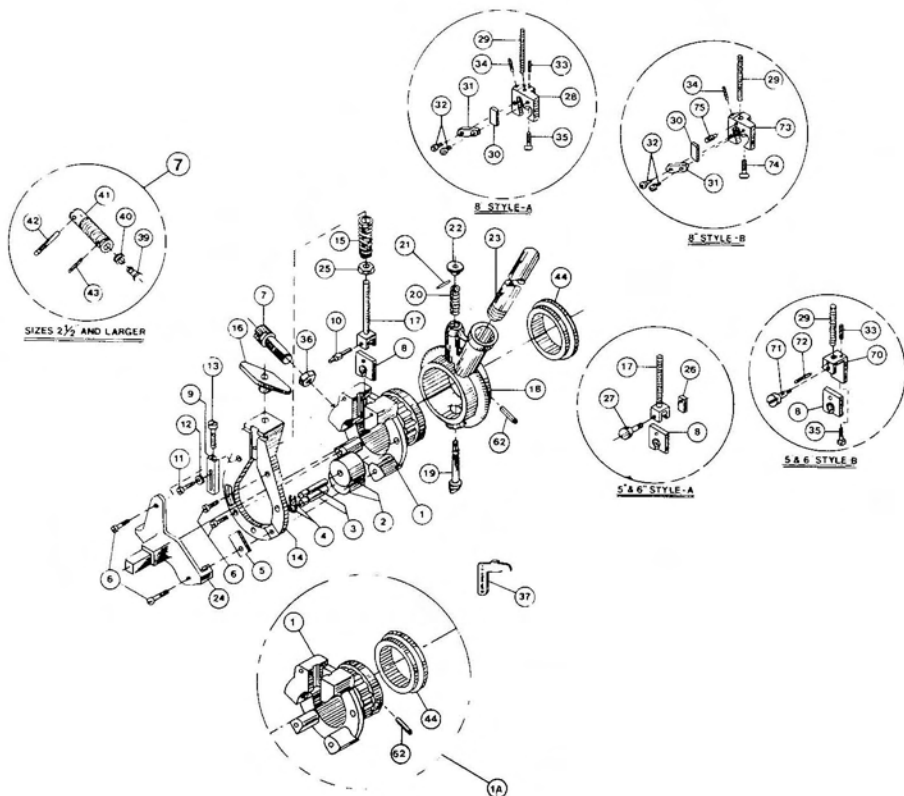

PARTS — 4"-6" ADJUSTABLE VIC-GROOVER TOOL ONLY

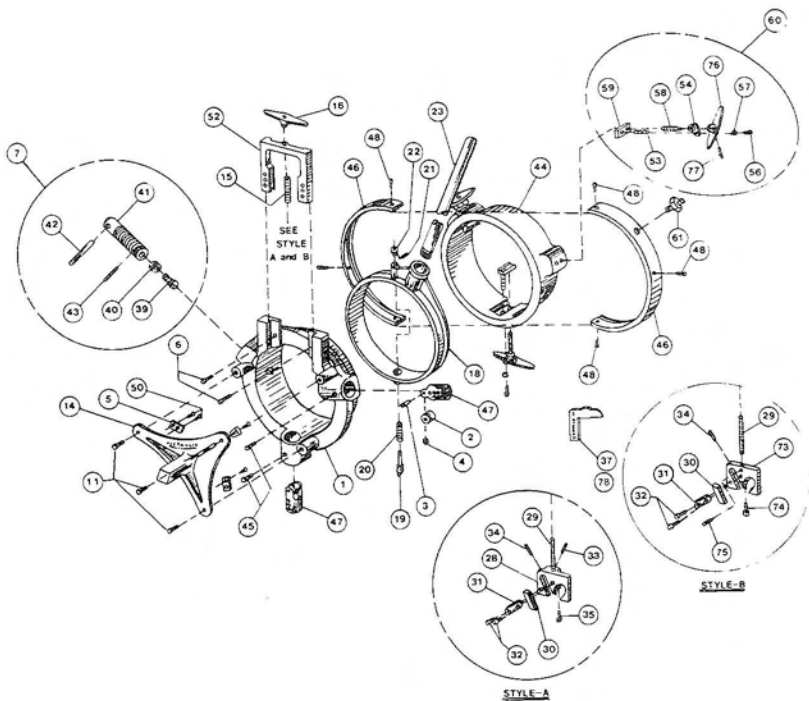

REPAIR PARTS LIST (Quan. Req'd.)

Part Number

SIZE KEY	3/4	1	1 1/4	1 1/2	2	2 1/2	3	3 1/2	4	5	6	8	4-6 ADJ.	3 CI	4 CI	6 CI
1	Body R-001-003-0VG (1)		R-001-005-0VG (1)	R-001-010-0VG (1)	R-001-014-0VG (1)	R-001-020-0VG (1)	R-001-024-0VG (1)	R-001-032-0VG (1)	R-001-046-0VG (1)	R-001-054-0VG (1)	R-001-062-0VG (1)	R-001-074-0VG (1)	R-001-082-0VG (1)	R-001-094-0VG (1)	R-001-102-0VG (1)	R-001-122-0VG (1)
1A	Body Assembly R-014-003-0VG (1)		R-014-005-0VG (1)	R-014-006-0VG (1)		R-014-010-0VG (1)	R-014-014-0VG (1)	R-014-016-0VG (1)	R-014-018-0VG (1)	R-014-020-0VG (1)	R-014-024-0VG (1)	R-014-028-0VG (1)	R-014-032-0VG (1)	R-014-036-0VG (1)	R-014-038-0VG (1)	R-014-042-0VG (1)
2	Roller R-002-003-0VG (1)		R-002-005-0VG (2)	R-002-006-0VG (2)	R-002-008-0VG (2)	R-002-010-0VG (2)	R-002-012-0VG (2)	R-002-014-0VG (2)	R-002-016-0VG (2)	R-002-018-0VG (2)	R-002-020-0VG (2)	R-002-022-0VG (2)	R-002-024-0VG (2)	R-002-026-0VG (2)	R-002-028-0VG (2)	R-002-032-0VG (2)
3	Roller Pin					R-003-003-0VG (2)						R-003-002-0VG (2)			R-003-003-0VG (2)	
4	Ret. Ring															
5	Pipe End Stop		R-005-003-0VG (1)													R-005-015-0VG (3)
6	3/16 - 18 x 1/4 Flilster Hd. Slt. Scr. B.Z.P.															
7	Clamp Screw (Assembly)		R-007-004-0VG (1)													
8	Grooving Knife		R-008-003-0VG (1)													
9	Knife Stop Guide				R-009-003-0VG (1)											
10	Knife Stop				R-010-003-0VG (1)											
11	1/4 x 20 x 3/4 Flilster Hd. Slt. Scr. B.Z.P.															
12	1/4 SAE Flat Washer B.Z.P.															
13	Guide Adjusting Screw															
14	Cover		R-014-003-0VG (1)	R-014-005-0VG (1)	R-014-010-0VG (1)	R-014-014-0VG (1)	R-014-020-0VG (1)	R-014-024-0VG (1)	R-014-032-0VG (1)	R-014-036-0VG (1)	R-014-042-0VG (1)	R-014-046-0VG (1)	R-014-054-0VG (1)	R-014-062-0VG (1)	R-014-074-0VG (1)	R-014-082-0VG (1)
15	Feed Spring															
16	Wing Handle															
17	Knife Holder															
18	Ratchet Housing															
19	Ratchet Pawl															
20	Ratchet Spring															

REPAIR PARTS LIST (con't.) (Quan. Req'd.) Part Number

SIZE KEY	DESCRIPTION	¾	1	1¼	1½	2	2½	3	3¾	4	5	6	8	4-6 ADJ.	3 CI	4 CI	6 CI
21	¾ x 7/8 Type 5 Groove Pin																
22	Ratchet Knob																
23	Ratchet Handle																
24	Yoke																
25	¾-16 Hex Jam Nut B.Z.P.																
26	Groove Depth Stop																
27	Depth Stop Screw																
28	Tool Bit Holder																
29	Tool Bit Holder Stem																
30	Tool Bit																
31	Link																
32	#10-32 x ¾ Soc. Hd. Cap																
33	#10-32 x ¾ Knurl Pt. Set Scr																
34	#10-32 x ¾ Oval Pt. Set Scr																
35	Depth Stop																
36	¾-9 Hex Nut B.Z.P.																
37	Template																
38	Grooved Roller																
39	Plunger																
40	Clamp Screw Spring																

REPAIR PARTS LIST (con't.) (Quan. Req'd.)

Part Number

SIZE KEY	DESCRIPTION	¾	1	1¼	1½	2	2½	3	3½	4	5	6	8	4-6 ADL.	3 CI	4 CI	6 CI
41	Clamp Screw																
42	¼ x 1¼ Type 5 Groove Pin																
43	¾ x ½ Type 2 Groove Pin																
44	Bushing																
45	¾ - 16 x 1 Hex Hd. Cap B.Z.P.																
46	Adapter Ring Assy.																
47	Roller Carrier																
48	#10-32 x ¾ Soc. Hd. Cap Scr.																
50	#10-32 x ½ Flat Hd. Cap Nylok																
52	Knife Carrier																
53	Guide Post																
54	Guide Post Link																
56	¼ - 20 x ½ Rind. Hd. St. Scr. B.Z.P.																
57	¼ Std. Lockwasher 6.Z.P.																
58	Adjusting Screw																
59	Jaw																
60	Clamp Assembly																

REPAIR PARTS LIST (con't.) (Quan. Req'd.) Part Number

SIZE KEY	DESCRIPTION	¾	1	1¼	1½	2	2½	3	3½	4	5	6	8	4-6 ADJ.	3 CI	4 CI	6 CI
61	Hyd. Lub. Fit.													(1) H-801-005-005			
62	¾x Roll Pin	(1) H-P80-000-003		(1) H-P80-000-002			(1) H-P80-000-002		(1) H-P80-000-002						(1) H-P80-000-002		
63	Pipe End Stop "ES" (Straight)		(1) R-063-008-016		(2) R-063-008-016		(2) R-063-008-016		(2) R-063-008-016				(2) R-063-008-016				
64	Growing Knife "ES" "ES" (Angled)					(1) R-064-008-016				(1) R-064-016-016			(1) R-064-024-016				
65	Pipe End Stop "ES" (Angled)						(1) R-065-016-016			(1) R-065-016-016			(1) R-065-016-016				
66	Growing Knife "Stainless" "PVC Plastic"	(1) R-066-003-016		(1) R-066-003-016			(1) R-066-014-016		(1) R-066-020-016				(1) R-066-032-016	(1) R-066-046-016			
67	Feed Spring "PVC Plastic"			(1) R-067-003-016			(1) R-067-014-016						(1) R-067-032-016	(1) R-067-046-016			
68	Feed Spring "PVC Plastic"						(1) R-068-003-016										
69	Pipe End Stop "Clf"															(1) R-069-015-001	
70	Knife Holder																(1) R-070-020-016
71	Knife Screw																(1) R-071-020-016
72	¾x x 1 Roll Pin																(1) H-P80-000-003
73	Tool Bit Holder												(1) R-073-032-016	(1) R-073-046-016			
74	Depth Stop												(1) R-074-032-016				
75	#10-32 x ¾ Brass Tip Set Scr.													(1) H-S83-000-006			
76	Clamp Handle																(3) R-076-046-016
77	¼ x ¼ Lp. Roll Pin																(3) H-P01-020-012
78	Template																(1) R-037-014-016



VICTAULIC COMPANY OF AMERICA

World Headquarters

P.O. Box 31 • Easton, PA 18044-0031
4901 Kesslersville Road • Easton, PA, USA 18040
Phone: 610/559-3300 • FAX: 610/250-8817
http://www.victaulic.com • e-mail: vic@mail.com

U.S. BRANCH SALES OFFICES AND SERVICE CENTERS

Northeast

7 Forge Parkway
Franklin, MA 02038
Phone: 508/528-7500
FAX: 508/528-7550

New York Metro

4901 Kesslersville Road
Easton, PA 18040
Phone: 800/742-5842
FAX: 800/437-6573

East Coast

6600 Amberton Drive
Elkridge, MD 21075
Phone: MD-410/796-0500
DC-301/621-2360
FAX: 410/796-1974

Southeast

4290 International Blvd.
Norcross, GA 30093
Phone: 770/925-1161
FAX: 770/381-7391

Mid-Atlantic

166 Thorn Hill Road
Warrendale, PA 15086
Phone: 412/931-1693
FAX: 412/776-0730

Mid-West

730 Thomas Drive
Bensenville, IL 60106
Phone: 630/595-8310
FAX: 630/595-8324

Great Lakes

23107 Commerce Drive
Farmington Hills, MI 48335
Phone: 248/471-3600
FAX: 248/471-4061

Central States

5900 Deramus Avenue
Kansas City, MO 64120
Phone: 816/241-4521
FAX: 816/241-6258

Mid-Continent

7177 Railspur Street
Houston, TX 77078
Phone: 713/635-6865
FAX: 713/635-1743

Permian Basin

2650 Remington Road
Odessa, TX 79763
Phone: 915/332-1489
FAX: 915/332-4924

Rocky Mountain

5045 Paris Street
Denver, CO 80239
Phone: 303/371-1320
FAX: 303/371-1324

Pacific - North

22633 83rd Ave. So.
Kent, WA 98032
Phone: 253/872-2200
FAX: 253/872-2203

Pacific - South

20934 So. Santa Fe Ave.
Long Beach, CA 90810
Phone: 310/537-1691
FAX: 310/537-9536

VICTAULIC TECHNICAL SERVICES DIVISION

1818 Vultee Street
Allentown, PA 18103
Phone: 610/559-3488
FAX: 610/923-3170

VICTAULIC FIRE SAFETY COMPANY, LLC

P.O. Box 31
Easton, PA, USA 18044-0031
Phone: 610/559-3300
FAX: 610/250-8817

VICTAULIC TOOL COMPANY

1326 Tatamy Road • Easton, PA 18045-7400
Phone: 610/559-3300 • FAX: 610/250-7065
Tool Shipments:
1326 Tatamy Road, Easton, PA 18045-7400
Sales & Lease Payments:
P.O. Box 8588-244, Phila., PA 19171-0244

VICTAULIC COMPANY OF CANADA

Canadian Headquarters

65 Worcester Road • Rexdale, Ontario • Canada M9W 5N7
Phone: 416/675-5575 • FAX: 416/675-5565

CANADIAN BRANCH SALES OFFICES AND SERVICE CENTERS

Eastern

975 rue Selkirk
Pointe Claire, PQ H9R 4S4
Phone: 514/426-3500
FAX: 514/426-2818

Ontario South

65 Worcester Road
Rexdale, ON M9W 5N7
Phone: 416/675-5575
FAX: 416/675-5729

Ontario North

1070 Elisabetha Street
Sudbury, ON P3A 5K2
Phone: 705/560-9595
FAX: 705/560-9490

Western

15353 114th Avenue
Edmonton, AB T5M 3S9
Phone: 403/452-0680
FAX: 403/452-2430

Pacific

Unit 5, 7560 Vantage Way
Delta, BC V4G 1H1
Phone: 604/940-3301
FAX: 604/940-3360

VICTAULIC INTERNATIONAL

P.O. Box 31 • Easton, PA, USA 18044-0031
4901 Kesslersville Road • Easton, PA, USA 18040
Phone: 610/559-3300 • FAX: 610/559-3608

VICTAULIC EUROPE

Industriepark Kwatrecht/Neerhonderd 37
B-9230 Wetteren Belgium
Phone: 011-32-93-694454 • FAX: 011-32-93-662553



Victaulic® Factory Representatives and Distributor Stocks Worldwide

Victaulic reserves the right to change product specifications, designs and standard equipment without notice and without obligation.